



On Track To KINDERGARTEN

Question of the Week:

Have you ever flown in an airplane?

___ Yes ___ No

April - Week 4

 Sing OLD McDONALD. 

Show how you look when you feel:

- Sad
- Happy
- Angry
- Afraid
- Sleepy
- Surprised
- Worried

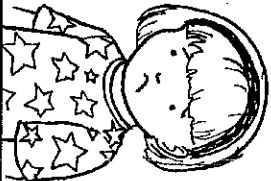
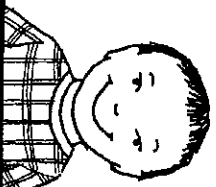

Visit a playground. Did you go on the:

- Monkey bars?
- Swings?
- slide?

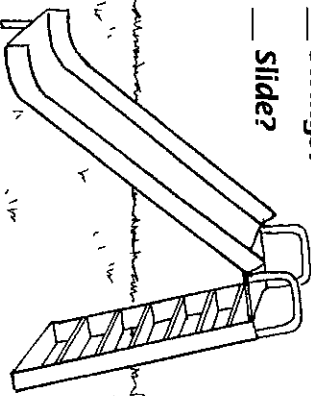

Have someone read to you.

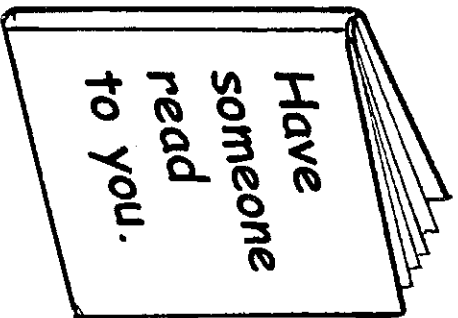

Draw a picture of a rainy day. Tell another person about it.

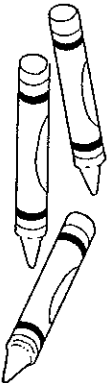
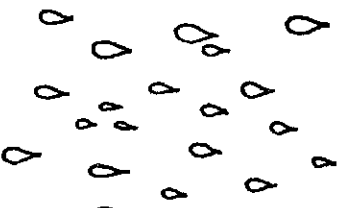

Child's Name _____

Parent's Name _____

Building Blocks

www.bblocks.com

a rainy day

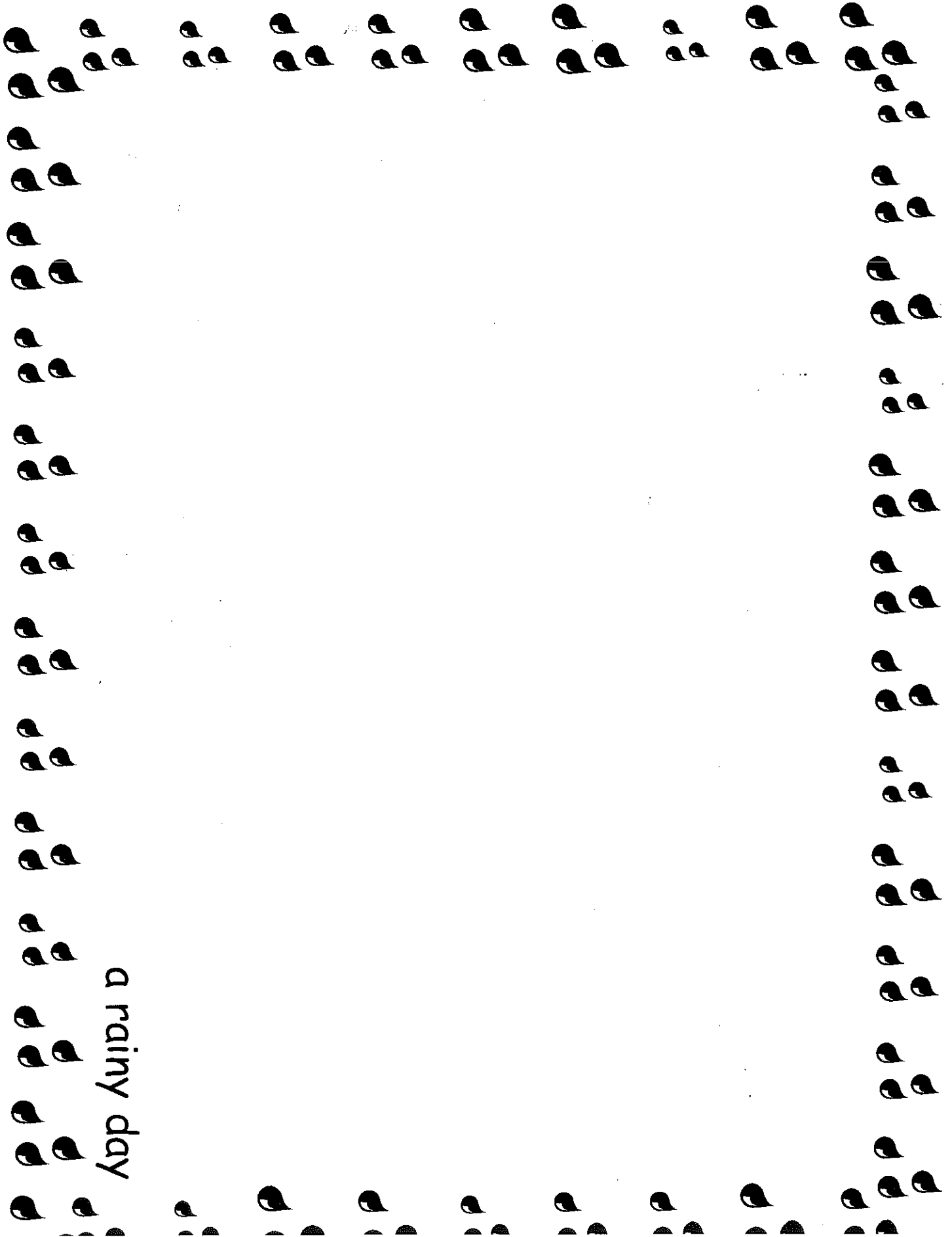

OLD McDONALD
HAD A FARM

Old McDonald had a farm,
E-I-E-I-O.
And on this farm he had a dog,
E-I-E-I-O.

With an arf-arf here,
And an arf-arf there.
Here an arf, there an arf,
Everywhere an arf-arf.
Old McDonald had a farm,
E-I-E-I-O.

And on this farm he had some ducks, E-I-E-I-O.
With a quack-quack here, and a quack-quack there.
Here a quack, there a quack,
Everywhere a quack-quack.
Old McDonald had a farm, E-I-E-I-O.

Continue:

Cows - moo-moo

Pigs - oink-oink

Horses - neigh-neigh

Cats - meow-meow

